







# PRESIDENT 3

## DIMENSION

Size : 63 Sqm. | Height : 3.8 m.

						
Cocktail Reception	Banquet-Style	Theatre Style	Classroom Style	Cabaret (m)	U-Shape	Conference Hollow
20	20	30	18	24	10	20

Classroom Style

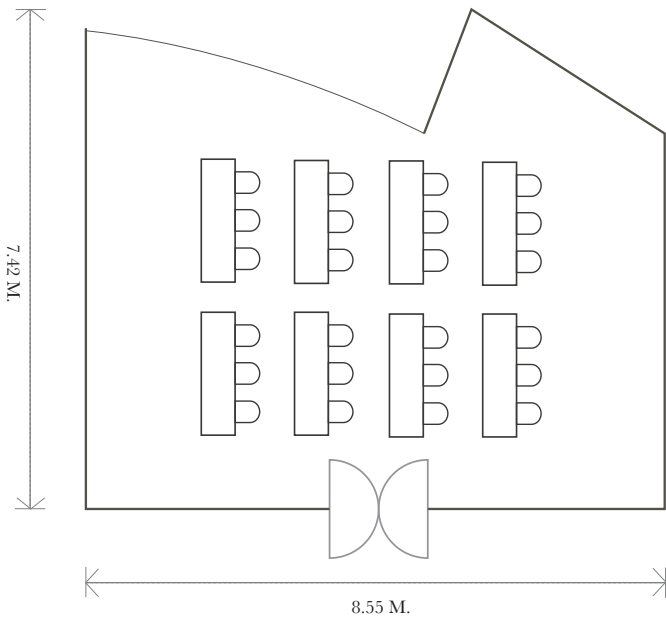

Banquet Style

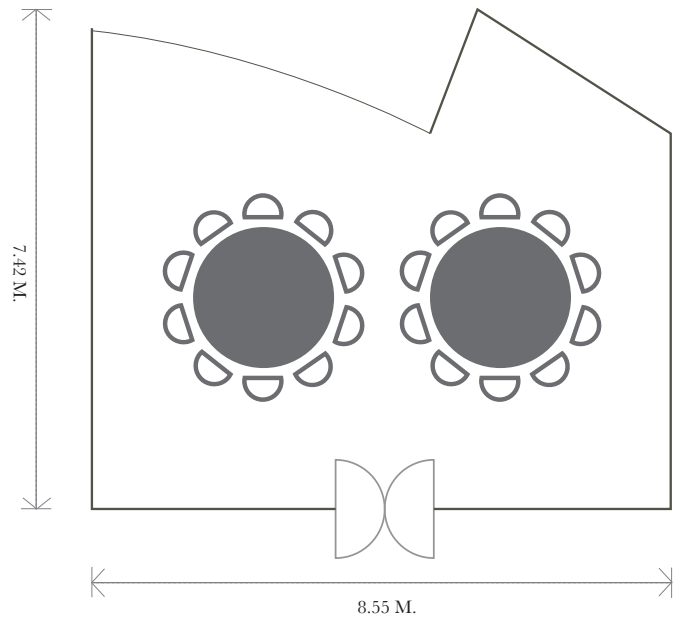

U-Shape

